

USER MANUAL

HYBRID SOLAR INVERTER

5KW-6KW

Contents

1 Safety Precautions	1
2 Installation	3
2.1 Inspection For Unpacking	3
2.2 Installation Requirements	3
2.3 Equipment Installation	4
2.4 Product Overview	5
2.5 Battery Connection	6
2.6 AC Input/Output Connection	6
2.7 Inverter Circuit Diagram	7
3 Operating	8
3.1 Inverter Screen Function	8
3.2 LCD Display Icons	9
3.3 System Standby	9
3.4 Display Data	10
3.5 LCD Setting	12
3.6 Language Setting	14
3.7 System Mode Setting	14
3.8 Battery Type Setting	16
3.9 System Mode Setting	17
3.10 Alarm Setting	18
3.11 Clock Setting	18
3.12 Record Query	19
3.13 Record Delete	19
3.14 Factory Recover Setting	20
4 Trouble Shooting	21
5 Protection And Cleaning	23
6 Removal	24
7 Technical Data Sheet	25

Chapter 1 Safety Precautions

Safety Of Operation

1. Please read this instruction carefully before use this inverter to ensure correct installation and safe operation.
2. Please pay attention to any warning signs and unusual when using this inverter.
3. Please don't place this inverter under direct sunlight, rain or moisture environment.
4. Please don't install this inverter near heat/heater/furnaces etc.
5. Please Install this inverter in a safe and empty space to ensure ventilation and heat dissipation, also easy to maintenance.
6. Please use dry and insulating rag to clean.
7. In the case of fire, please use a dry powder fire extinguisher to put out fire. Liquid fire extinguisher is prohibited.
8. Please choose a right space for the inverter installation and Battery pack powerful enough for the inverter.
9. Please make sure the appliances and battery capacity matches inverter rated power.

Prohibition

1. Please don't open the inverter shell if without authorization. The inverter inbuilt with high voltage component. If failed to follow instruction, there will be possibilities for electric shock and void of warranty.
2. If your appliances as follow, please consult with your local dealer or distributor before you install this inverter about its application/set-up/management and maintenance.
 - 1) Precision industrial/scientific and medical instruments or equipment.
 - 2) Elevators and other equipment that may endanger personal safety.
 - 3) Equipment that start up with large current and generating negative work.
3. Don't place the battery into fire to avoid explosion.

Safety Of Electric

1. Please make sure inverter been properly grounded and all cable connect in the right socket, also the battery polarity in the right position.
2. To protection your battery, please place a circuit breaker with over-current protection between inverter and battery.
3. If need reconnect the inverter cable, please make sure inverter is completely shut down and input breaker /battery switch is off, failed to follow this procedure, there will be possibilities for electric shock.

Safety Of Battery

1. The life span of the battery will be shortened if environment temperature increases. Replace battery regularly will make sure inverter working normally and ensure enough backup power.
2. The replacement and maintenance of battery must be made by authorized battery expertise. Must be same type of battery and same capacity with the same quantity.
3. There will be possibilities for electric shock and short-circuit, in order to avoid that, please follow below instruction.
 - A. Please remove your watch/ring/earring or any metal accessory.
 - B. Please use insulated tools.
 - C. Please wear rubber shoes and gloves.
 - D. Please don't place any metal tools or any metal component on the battery.
 - E. Please shut down all appliances before remove battery terminals.
 - F. Non-professionals please don't disassemble battery or damage battery, battery contain dangerous acid which could cause damage to the skin and eyes. If touch accidentally, please wash it off with water and go to hospital for more medical examination.
 - G. Please second confirm the battery cable positive and negative terminals before connect to battery.
 - H. Please install circuit breaker on battery to prevent fire and electrical shock.

Operation And Maintenance

1. The operation and storage environment is concerning the inverter life span and reliability. Therefore, please do not place the inverter in following environment:
 - A. Temperature/humidity exceed Inverter working environment standard. Inverter could work in be 0-55°C □ 0-95% humidity environment with no condensation.
 - B. Any place where will be vibration and collision.
 - C. Any place where metallic dust/corrosive substances/salt and flammable gasses.
2. Inverter must storage in dry environment if not use for certain amount of time.
3. The environment temperature must increase above 0°C for 2 hours before start up the inverter.
4. Please keep the inverter ventilation holes open, so inverter could ventilate. Insufficient of air will cause inner temperature go up and shorten inner component life span so does the inverter.
5. If not use battery for long time, pls recharge battery for every 3 months.

Chapter 2 Installation

2.1 Inspection For Unpacking

1. Open the package, carton should included following item:

- 1) Inverter one set
- 2) User manual one unit

2. Before opening the inverter package, please check and confirm if the inverter damaged during transportation. If any damaged or missing parts, please contact local dealer or distributor.



Recycling: The carton packing is reusable, please don't throw away.

2.2 Installation Requirements

1. Please make sure it's professional electrician install this inverter. With following instruction:

- 1) Please do not place anything on top of the inverter.
- 2) The installation space should match the inverter size.
- 3) Please do not install the inverter on the wall which made by flammable or heat-resistant material.
- 4) Please install the inverter as picture show for easy inspection and maintenance.
- 5) Please do not install the inverter under direct sunlight.
- 6) Install environment humidity should be 0-95% with no condensation.
- 7) Environment temperature should be 0-55°C.
- 8) Please leave enough space between the inverter as picture shown.

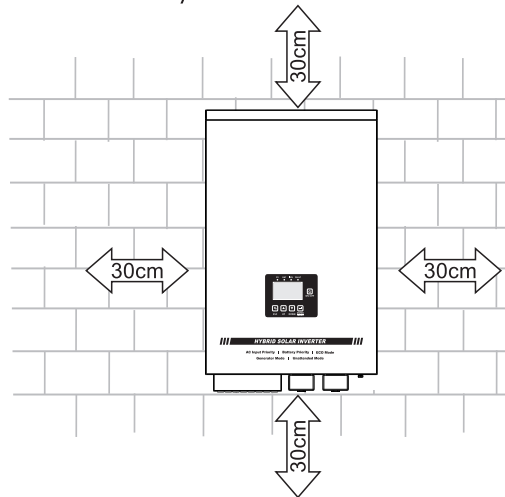

Above mentioned only suitable for ground mounted or other non-flammable surfaces.

2.3 Equipment Installation



Remember that this inverter is heavy! Please be careful when lifting out from the package.

The inverter is suitable for mounting on concrete or other non-combustible surface only.

Step 1

- Please use the mounting back plate as a template to drill 4 holes (diameter 8 mm, depth 60 mm)
- Use the random bolts in the accessory box to firmly fix the mounting back plate to the wall. (See Pic 1)

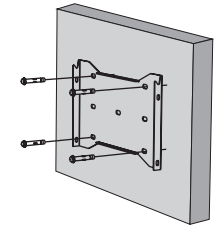

Pic 1

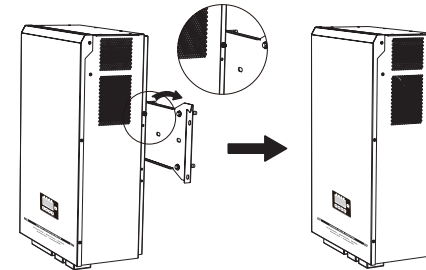

Pic 2

Step 2

- Fix the bolts on the inverter. Do not tighten the screws.
- Two persons are required to hold the inverter and fix the inverter on the installation backplane. (See Pic 2)

Step 3

- Fix the inverter with the M5 screws in the accessories. (See Pic 3)

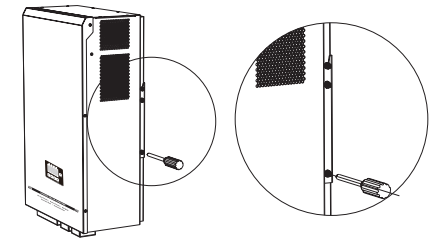

Pic 3

2.4 Product Overview

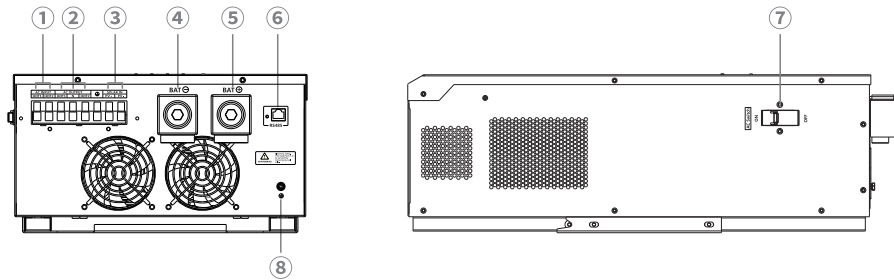

- 1. AC Input 2. AC Output 3. Solar In
- 4. Battery- 5. Battery+ 6. RS485 communication port
- 7. AC Switch 8. GND

2.4.1 Device side - female connector

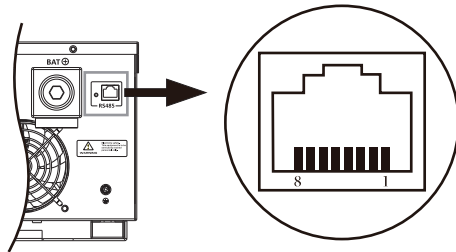

Pin on Rj45	Name	Description
1	A	Generator terminal 0
2	B	Generator terminal 1
8	GND	Signal and optional Power Supply common

2.5 Battery Connection

CAUTION: For safety operation and regulation compliance it's requested to install a separate DC over-current protector or disconnect device between battery and inverter. It may not be requested to have a disconnect device in some applications, however, it's still requested to have over-current protection installed. Please refer to typical amperage in below table as required breaker size.

WARNING! All wiring must be performed by a qualified personnel.

WARNING! It's very important for system safety and efficient operation to use appropriate cable for battery connection. To reduce risk of injury please use the proper recommended cable as below.

Recommended battery cable size:

Model	Cable(mm ²)	Circuit Breaker
24V/5KW	25mm ²	300A
48V/5KW	25mm ²	150A
24V/6KW	25mm ²	350A
48V/6KW	25mm ²	200A

2.6 AC Input/Output Connection

CAUTION!! Before connecting to AC input power source, please install a separate AC breaker between inverter and AC input power source. This will ensure the inverter can be securely disconnected during maintenance.

CAUTION!! Please do NOT mis-connect input and output connectors.

WARNING! All wiring must be performed by a qualified personnel.

WARNING! It's very important for system safety and efficient operation to use appropriate cable for AC input connection. To reduce risk of injury please use the proper recommended cable size as below.

Suggested cable requirement for AC wires:

Model	Gauge	Circuit Breaker
5KW	10AWG	32A 2P
6KW	10AWG	40A 2P

2.7 Inverter Circuit Diagram

The machine with relatively high power is connected to the mains input and load output through the terminal block. The load output is output in addition to the terminal block mode.

Caveat! ! Please do not connect the output line to the "AC" terminal, and do not connect the AC to the "load" terminal.

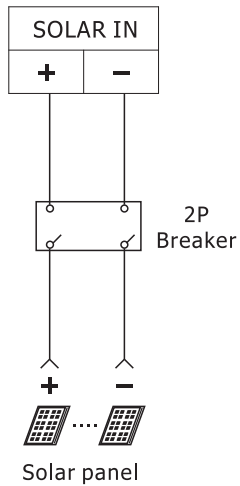
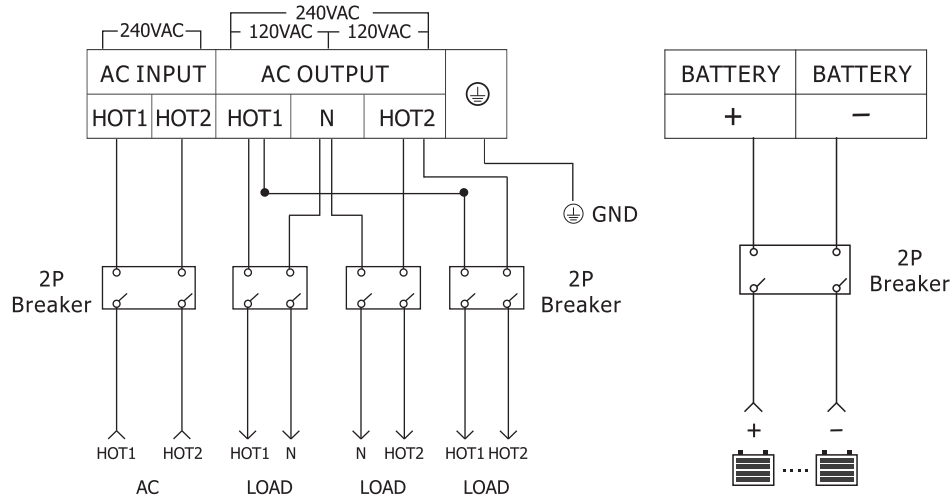

Chapter 3 Operating

3.1 Inverter Screen Function

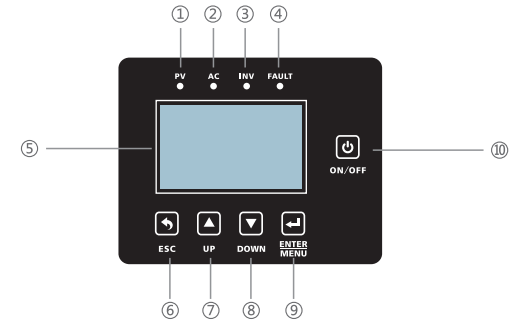

• Indicator status

Identification	Indicator light name	Status
①	PV	PV Normal
②	AC	AC Normal
③	Inverter	Battery inverter power supply
④	Fault/Warning	Warning/work abnormal

• LCD Display— ⑤ : Detailed display information

• Navigation keys: selection, opening, obtaining information, modifying system parameters, etc.

Identification	Navigation keys	Function
⑥	Enter	Return to the previous interface menu or exit the settings interface (do not save the settings)
⑦	UP	Page turning; switching options; adding settings value
⑧	Down	Page turning; switching options; minus setting values
⑨	ESC	Press and hold for 5 seconds to enter the setting interface; short press to confirm save or set to enter the setting submenu
⑩	Turn On/Off	Turn on or turn off the inverter

3.2 LCD Display Icons

The main interface description is as shown.

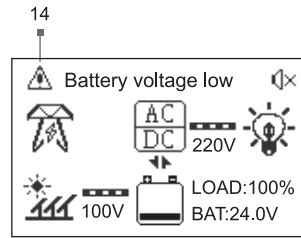
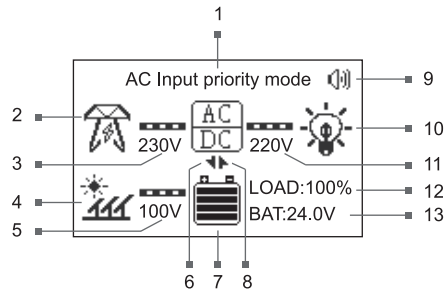

NO.	Description	NO.	Description
1	System Mode	8	Battery Inverter
2	AC	9	Alarm Status
3	AC Input Voltage	10	Load
4	PV	11	Output Voltage
5	PV Input Voltage	12	Load Capacity
6	AC Charging	13	Battery Voltage
7	Battery	14	Fault Info

3.3 System Standby

In the unattended mode, the battery voltage will be too low to enter the system standby.

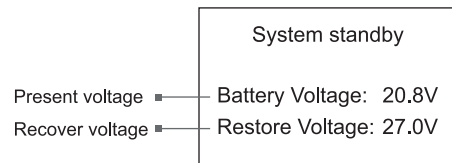

3.4 Display Data





In the default main interface, press the "UP" or "DOWN" button to scroll through the pages. Under the main page, long press the back and down keys to restore the factory settings.



Icon	Parameter Interface	LCD display
①	AC Input Parameter	<p>AC Input parameter</p> <p>Voltage: 222V</p> <p>Freq: 50Hz</p> <p>Status: AC input normal</p>
②	PV Parameter	<p>PV Parameter</p> <p>PV Voltage: 80V</p> <p>PV Current: 100A</p> <p>PV Status: PV loss</p>
③	Energy Parameter	<p>Energy Parameter</p> <p>Daily Energy: 744Wh</p> <p>Total Energy: 4.859KWh</p>
④	Daily Energy	<p>Daily Energy MAX: 53</p> <p>MAX:00.00Wh(Recorded the highest power generation value for a day)</p>

Icon	Parameter Interface	LCD display
⑤	Battery Parameter	<div style="border: 1px dashed gray; padding: 5px;"> <p style="text-align: center;">Battery parameter</p> <p>Battery Voltage: 27.3V Battery Capacity 100% Charging Voltage : 27.4V</p> </div>
⑥	Output Parameter	<div style="border: 1px dashed gray; padding: 5px;"> <p style="text-align: center;">Output Parameter</p> <p>Voltage: 222V Freq: 50Hz Status: Output off</p> </div>
⑦	System Information	<div style="border: 1px dashed gray; padding: 5px;"> <p style="text-align: center;">System Information</p> <p>2021-06-19 08:57:00 Hardware Version: 1.00 Software Version: 1.00</p> </div>

3.5 LCD Setting

In the default main interface, long press the "ENTER" for 5 seconds to enter the setup menu, press "DOWN" to scroll through the submenus. Set to battery priority mode, the default charge is off, you need to charge to the current settings page.

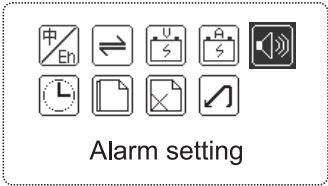
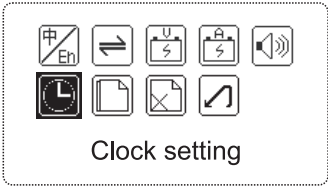
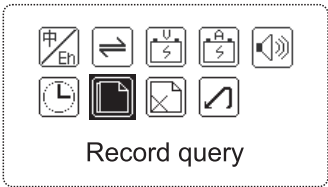
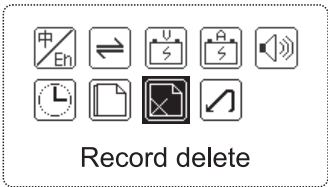
Icon	Parameter Interface	LCD display
①	Language setting	<div style="border: 1px dashed gray; padding: 5px;">  <p style="text-align: center;">Language setting</p> </div>
②	System mode setting	<div style="border: 1px dashed gray; padding: 5px;">  <p style="text-align: center;">System mode setting</p> </div>
③	Battery type setting	<div style="border: 1px dashed gray; padding: 5px;">  <p style="text-align: center;">Battery type setting</p> </div>
④	Charging current setting	<div style="border: 1px dashed gray; padding: 5px;">  <p style="text-align: center;">Charging current setting</p> </div>

Icon	Parameter Interface	LCD display
⑤	Alarm setting	 <p>Alarm setting</p>
⑥	Clock setting	 <p>Clock setting</p>
⑦	Record query	 <p>Record query</p>
⑧	Record delete	 <p>Record delete</p>
⑨	Factory recover setting	 <p>Factory recover setting</p>

3.6 Language Setting

In the default main interface, long press the "ENTER" for 5 seconds to enter the setup menu, press "DOWN" to select the language setting and press the "ENTER" to confirm, press the "ESC" to return to the menu or wait after the pop-up is successful. 2 seconds automatically returns to the menu.

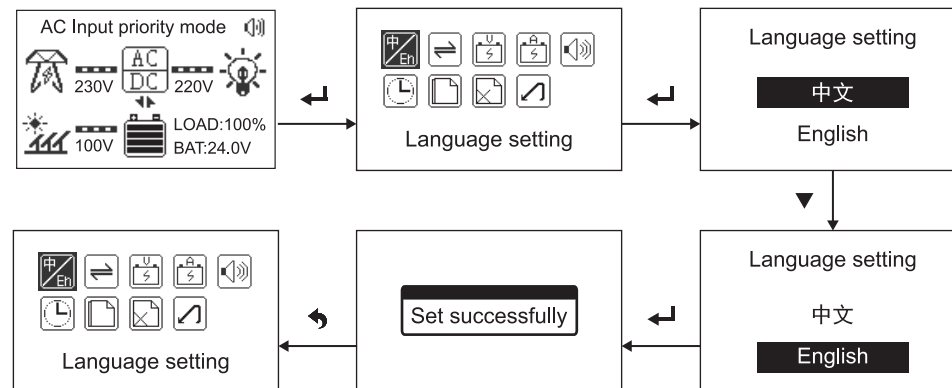

3.7 System Mode Setting

In the default main interface, long press the "ENTER" for 5 seconds to enter the setup menu, press the "DOWN" to select the system mode setting and press the "ENTER" to confirm, enter the mode selection press "DOWN" to select the option, pop-up settings After success, press the "ESC" to return to the menu or wait for 2 seconds to automatically return to the menu.

AC Priority Mode - The AC input(utility power/city grid) will supply power to AC output (applianes/load) first, and auto charge battery at the same time. Inverter will auto stop charging when battery been fully charged. When there is no AC input, inverter will auto switch to battery power supply.

Battery Priority Mode - The battery power will supply power to AC output (applianes /load).When battery voltage reach low voltage limit, if AC input is on, inverter will auto switch to AC input supply; If AC input is off,inverter will auto shut down.When battery fully charged,inverter will auto switch back to battery supply.

ECO Mode - Similar to AC priority mode. When AC input(utility power/city grid) is off, the inverter will auto enter standby status when appliances capacity under 5% inverter capacity.Inverter will keep auto switch between on and standby status in order to detect if AC output (applianes/load) capacity over 5% of the inverter capacity.If the AC output capacity over this above mentioned limit,inverter will auto switch from standby status to inverting status.

Generator mode - use unstable generator to generate power, access the inverter AC input. through the inverter AVR regulator, automatic matching 50HZ/60HZ municipal frequency, output voltage regulator in the normal operating range.

Unattended Mode - Similar AC priority mode. When AC input (utility power/city grid) is off, battery voltage is too low, the inverter will auto shut down AC output and enter STANDBY status. Once battery been charged it back to the restore voltage point, the inverter will restart the AC output. On the other hand, when AC input back on, inverter will auto restart AC output as well.

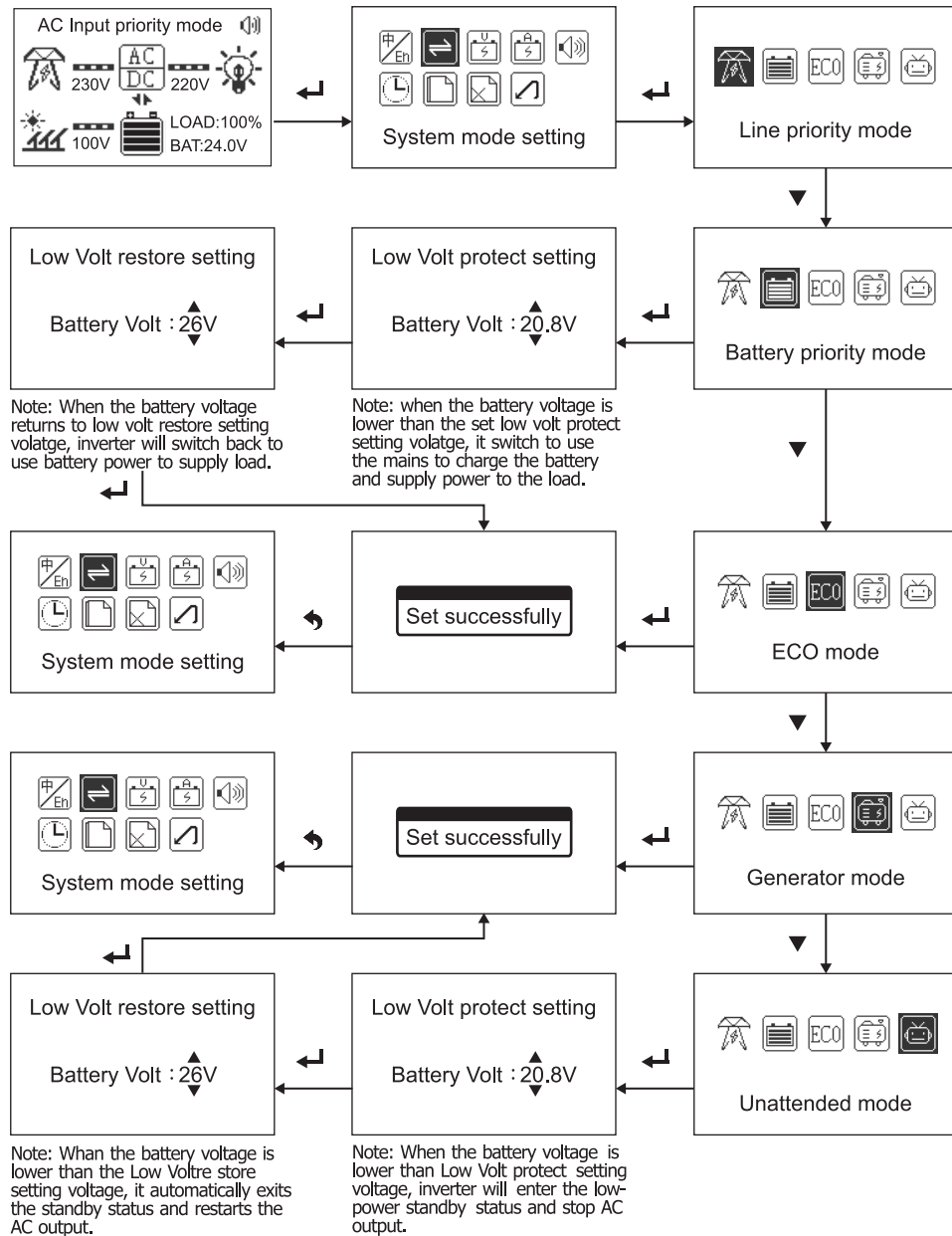

3.8 Battery Type Setting

In the default main interface, the long press "ENTER" 5 seconds into the settings menu, press "DOWN" to select battery type settings and then press "ENTER" confirmation, enter mode select press "DOWN" selection option, Press "ESC" to return to menu or wait for 2 seconds to automatically return to menu.

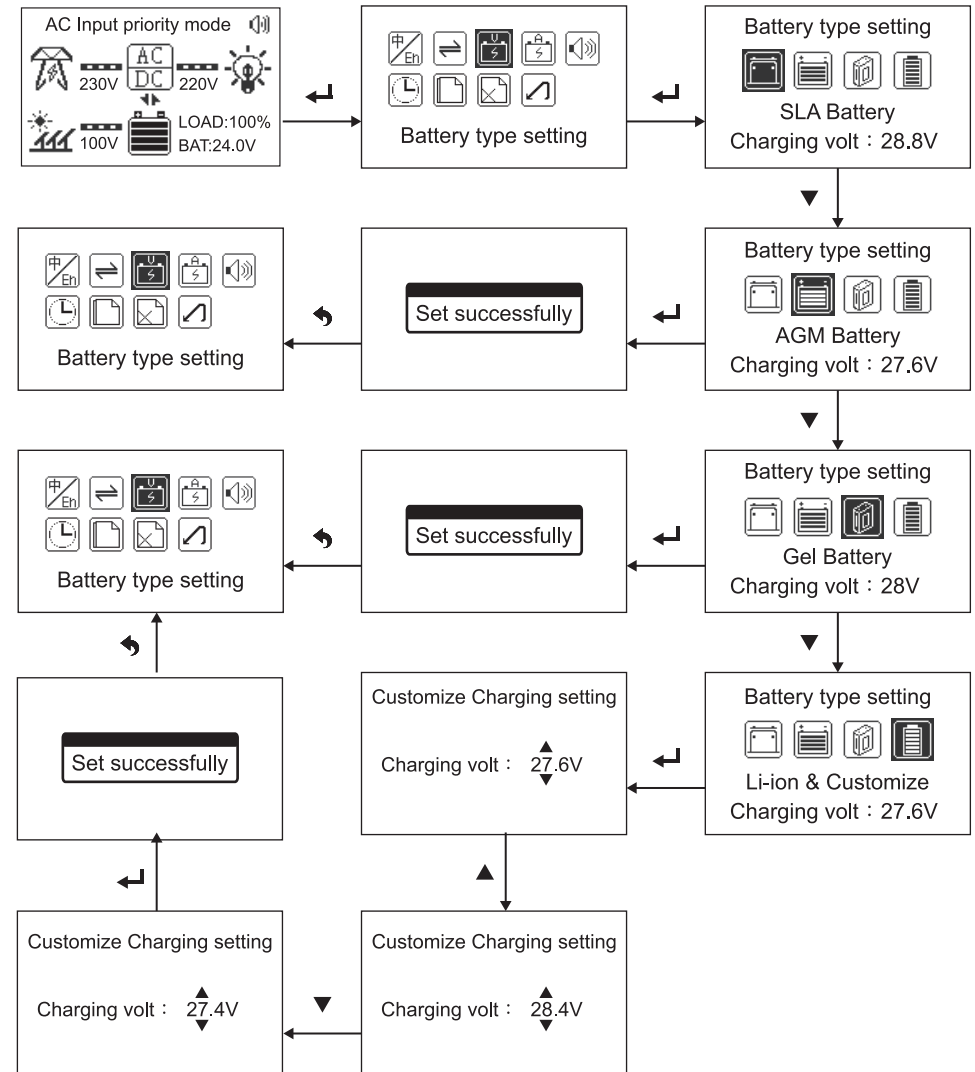

3.9 System Mode Setting

In the default main interface, long press the "ENTER" for five seconds to enter the setup menu, press the "DOWN" to select the charging current setting and press the "ENTER" to confirm, press the "DOWN" to modify the value, confirm the value and press to "ENTER", press the "ESC" to return to the menu after the pop-up setting is successful or wait for 2 seconds to automatically return to the menu.

Note: Setting the value to 0% will turn off the charging function.

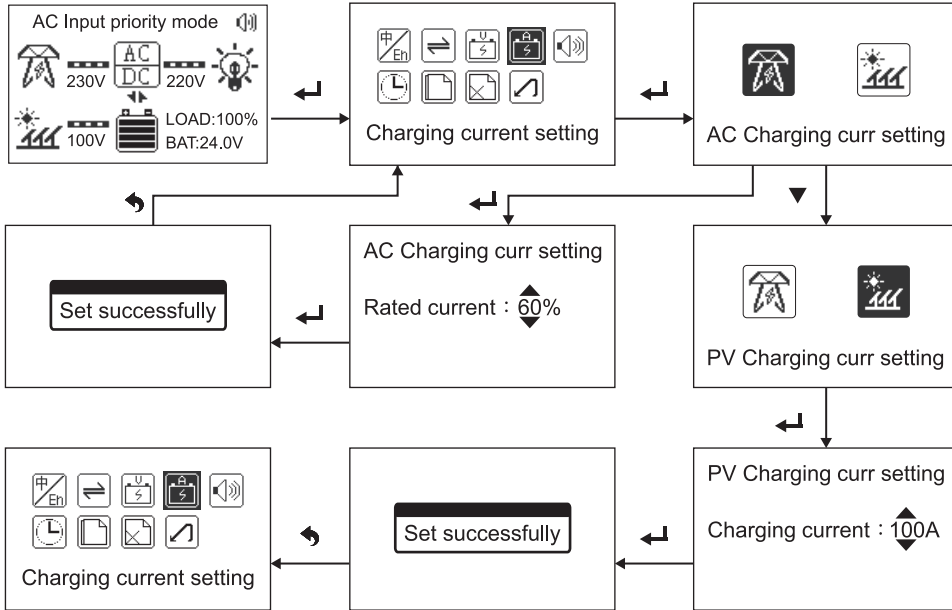

3.10 Alarm Setting

In the default main interface, long press the "ENTER" for five seconds to enter the setup menu, press the "DOWN" to select the alarm tone setting and press the "ENTER" to confirm, press the "ESC" to return to the menu or Wait 2 seconds to automatically return to the menu.

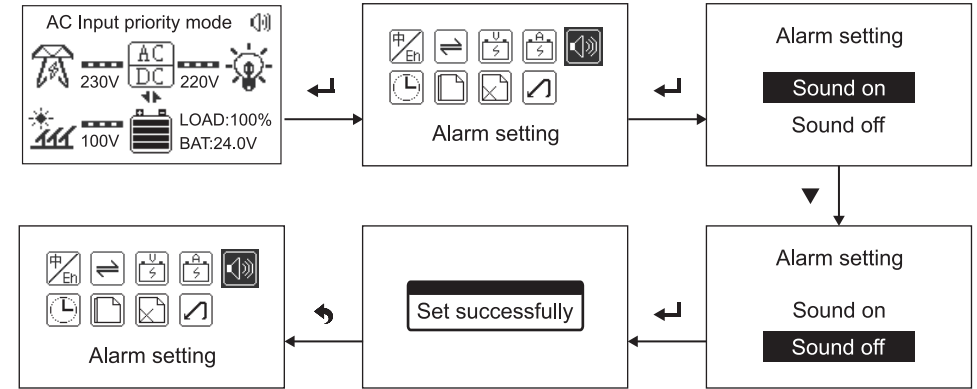

3.11 Clock Setting

In the default main interface, long press the "ENTER" for five seconds to enter the setup menu, press the "DOWN" to select the clock setting and press the "ENTER" to confirm, press the "ESC" to return to the menu or Wait 2 seconds to automatically return to the menu.

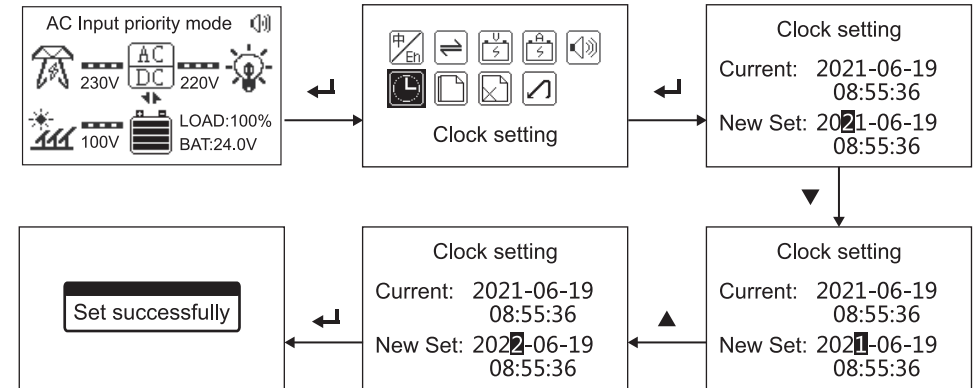

3.12 Record Query

In the default main interface, the long press "ENTER" 5 seconds into the settings menu, press "DOWN" to select record query and then press "ENTER" confirmation, Press "ESC" to return to menu or wait for 2 seconds to automatically return to menu.



3.13 Record Delete

In the default main interface, the long press "ENTER" 5 seconds into the settings menu, press "DOWN" to select record query and then press "ENTER" confirmation, Press "ESC" to return to menu or wait for 2 seconds to automatically return to menu.

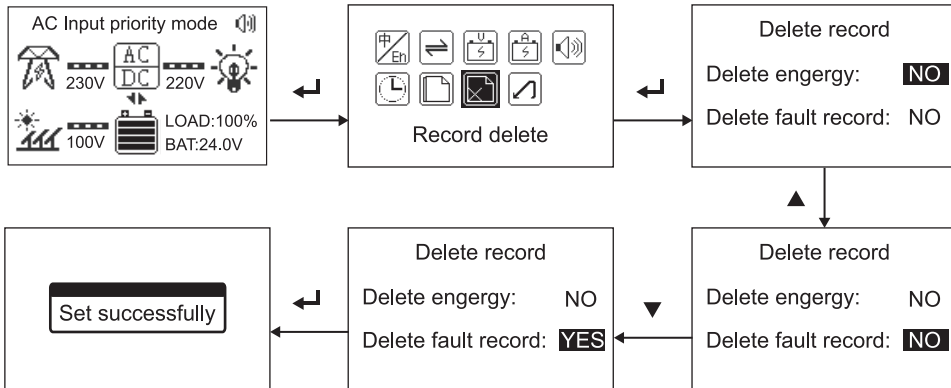

3.14 Factory Recover Setting

In the default main interface, long press the "ENTER" for five seconds to enter the setup menu, press the "DOWN" to select the factory recover setting and press the "ENTER" to confirm, press the "ESC" to return to the menu or Wait 2 seconds to automatically return to the menu.

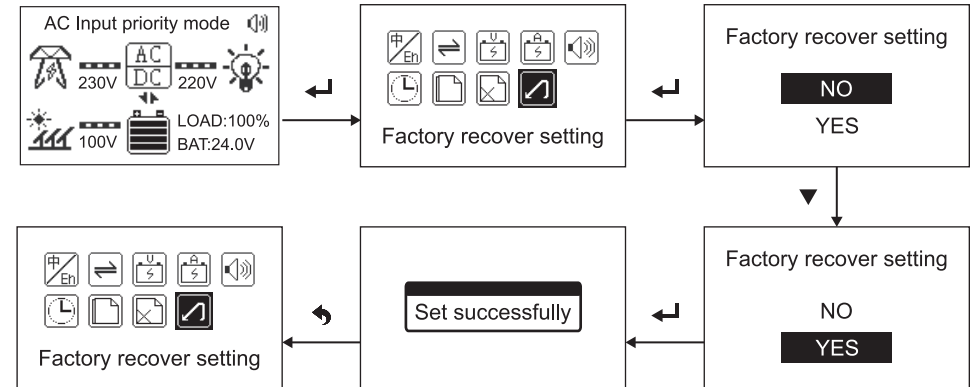

Chapter 4 Trouble Shooting

When the inverter is not working properly, we recommend the following solutions to eliminate common faults. The table below helps the technician understand the problem and take action.

Problem	LCD/LED/Buzzer	Explanation / Possible cause	What to do
Unit shuts down automatically	No indication or buzzer beeps continuously and red LED is on	The battery voltage is too low	1. Re-charge battery. 2. Replace battery.
Fan stop or slow running	No indication	Fan intelligent speed regulation or fan fault	1. A rise in temperature or load capacity will increase the running speed. 2. Replace the fan.
Output turns on for 1 second and then stops, repeating	ECO mode	This mode shuts off output when the load is less than 5%	1.The load > 5% will run continuously. 2.Change mode settings.
No response after power on	No indication	1. The battery voltage is far too low. 2. Battery polarity is connected reversed.	1. Check if batteries and the wiring are connected well. 2. Re-charge battery. 3. Replace battery.
Mains exist but the unit works in battery mode	Input voltage is displayed as 0 on the LCD	Input protector is tripped	Check if AC breaker is tripped and AC wiring is connected well.
	Input voltage is displayed in the normal range on the LCD	Insufficient quality of AC power. (Shore or Generator)	1. Check if AC wires are too thin and/or too long. 2. Check if generator (if applied) is working well or The input frequency is unstable or out of range.
	Green LED is lighten	Set "Battery priority mode" as the system mode	System mode is not set to "Battery priority mode".
Buzzer beeps continuously and red LED is on	Over current	Over current or surge	Reduce the connected load ,Restart the unit, if the error happens again, please return to repair center.
	Output short	Output Short or surge	

Problem	LCD/LED/Buzzer	Explanation / Possible cause	What to do
Buzzer beeps continuously and red LED is on	Over load	Over load error. The inverter is over load 110% and time is up	Reduce the connected load by switching off some equipment.
	Over temperature	Internal temperature of inverter component is over 80°C	Check whether the air flow of the unit is blocked or whether the ambient temperature is too high.
	Battery volt. high	Battery is over-charged.The battery voltage is too high	1. Check the setting of charger. 2. Check if spec and battery quantity of requirements.
	Battery voltage low	The battery voltage is too low	1. Re-charge battery. 2. Replace battery. 3. Check if spec and battery.
	Output voltage low	Output abnormal	1. Reduce the connected load. 2. Return to repair center.

Chapter 5 Protection And Cleaning

Check The Heat Dissipation

Please check environment temperature around the inverter. Make sure there is no clogging of the vents.

Cleaning the inverter will improve the heat dissipation of the inverter.

Cleaning The Inverter

Please turn off AC input first, shut down inverter ,then turn off the DC switch. Make sure all of them is completely off.

You could wipe the inverter with dry and insulated rag. Please don't use water and any liquid such as solvent or abrasive liquid.

Check Connection

Please check all cables or breakers regularly to see if there is abnormal heat. If there any damage of the cable and breaker, pls shut down all of component and contact a professional electrician for inspection.

Chapter 6 Removal

How To Remove The Inverter

- Shut down AC input.
- Shut down inverter.
- Shut down DC breaker.
- Remove all cables off the inverter.
- Carefully remove the inverter.

Inverter Packaging

Please keep the inverter original packaging in case of delivery. If you can't find the original packaging ,please use strong box with correct size to contain this inverter.

Inverter Processing



Please do not throw this in the garbage. In case of dispose this inverter, please follow local regulations about electronic component recycling.

Chapter 7 Technical Data Sheet

Model		5KW	6KW
Capacity	Rated Power	5KW	6KW
	Peak Power	15KW	18KW
Input	Battery Voltage	24V / 48V	
	DC Input Voltage	24V:21-30VDC / 48V:42-60VDC	
	AC Input Voltage	180-289VAC	
	AC Input Frequency	50Hz±5Hz	
Output	Effectiveness	≥90%	
	Output Voltage	(Inverter Mode) 120V/240VAC±3%	
	Output Frequency	(Inverter Mode) 50Hz±0.5Hz	
	Output Waveform	Pure Sine Wave	
AC Charging	Type Of Battery	SLA Battery / AGM Battery / Lithium Battery	
	AC Charging Current	0-35A	
Protection	Battery High Voltage Warning	24V:>30VDC / 48V:>60VDC	
	Battery High Voltage Protection	24V:>34VDC / 48V:>68VDC	
	Battery Low Voltage Warning	24V:<21VDC / 48V:<42VDC	
	Low Voltage Battery Shutdown	24V:<20VDC / 48V:<40VDC	
	Overload, High Temperature, Short Circuit Protection	Automatic Shutdown	
Other	Switchover	≤5ms	
	Display	LCD	
	Cooling System	Forced Air Cooling, Intelligent Speed Regulation	
	Operating Mode	AC Input Priority Mode / Battery Priority Mode / ECO Mode / Generator Mode / Unattended Mode	
	Communication	RS-485	
Working Environment	Temperature	0~55°C	
	Humidity	0~95%(No Condensation)	
Exterior	Product Size(mm)	596x363x193	
	N. W. (Kg)	33.5	36.5

• The technical specifications of this document are subject to change without any notice

MPPT Specifications

Model		5KW		6KW	
Charging Mode		Constant Current/Floating Charge/MPPT			
Overall Unit Efficiency	24V/48V	≥96.5%			
Photovoltaic Module Utilization	24V/48V	≤99%			
Solar Input Open Circuit Voltage		≤175V			
Solar Input Operating Voltage		≤150V			
Maximum PV Charging Current		80A	100A	80A	100A
Maximum PV Array Power	24V	2240W	2800W	2240W	2800W
	48V	4480W	5600W	4480W	5600W

Solar Panel Configuration Requirements

Rated Voltage (V)	Rated Current (A)	PV Module Load Voltage (Recommended Value)	Open Circuit Voltage 43V				Number Of Parallel Groups
			Max. Input Voltage(V)	Optimal Number Of Series	Max. Number Of Series	Minimum Number Of Series	
24V	80A	36V~72V	100V	2	3	1	Configured According To Power Consumption
24V	100A	36V~72V	100V	2	3	1	
48V	80A	72V~144V	150V	3	3	2	
48V	100A	72V~144V	150V	3	3	2	

• The technical specifications of this document are subject to change without any notice